

ET-03I-10-13-S-HI

Peltier Cooler Module

Data sheet

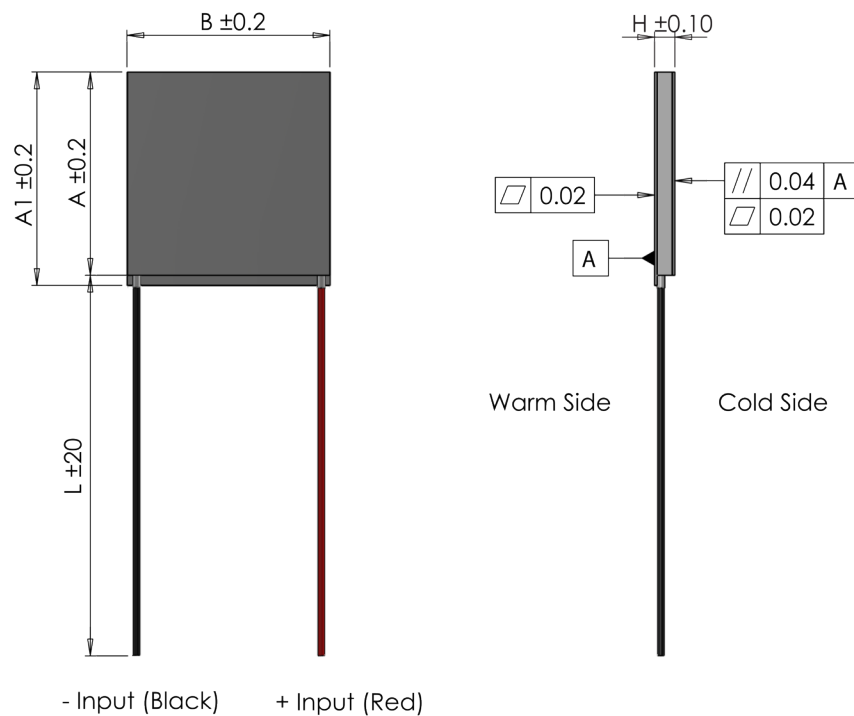

I_{max}	[A]	4.0
V_{max}	[Vdc]	3.9
$P_c \text{ max}$	[W]	8.6
ΔT_{max}	[°C]	73
A	[mm]	15
A1	[mm]	15
B	[mm]	15
H	[mm]	3.6
L	[mm]	100
Sealed		Silicone

- (At hot side temperature $T_h = 25^\circ\text{C} / 298\text{K}$, under dry N_2)
- $P_c \text{ max}$ = Cooling power at $\Delta T = 0$ and $I = I_{max}$
- ΔT_{max} = Temperature difference at $I = I_{max}$ and $P_c = 0$
- Max hot side temperature $T_h = 90^\circ\text{C}$ for best long term performance
- Max mounting pressure: 1.5MPa
- Wires: ULI569, 300V, 105°C



ET-03I-10-13-S-HI

Peltier Cooler Module

Data sheet - At hot side temperature 25°C

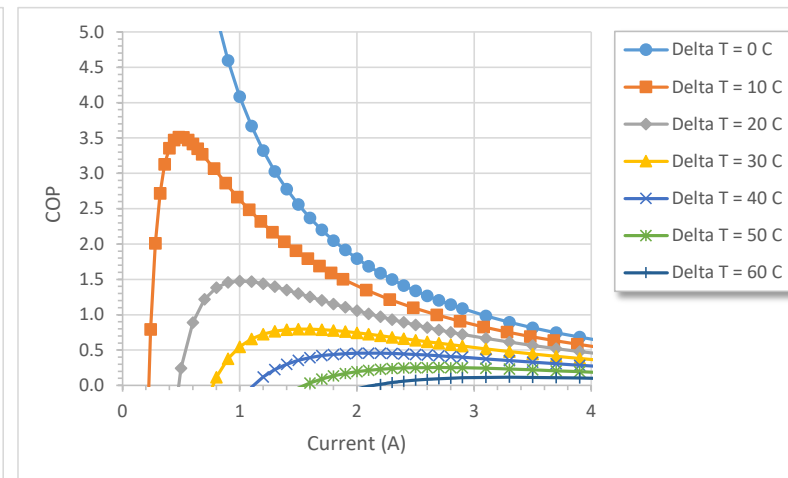
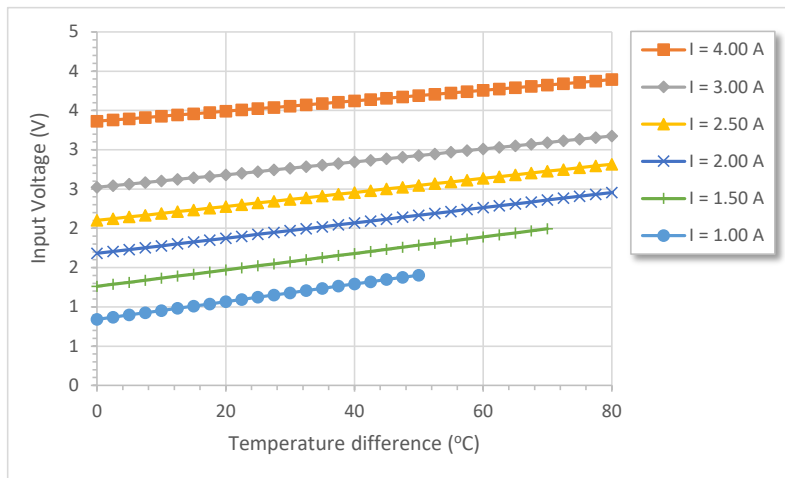
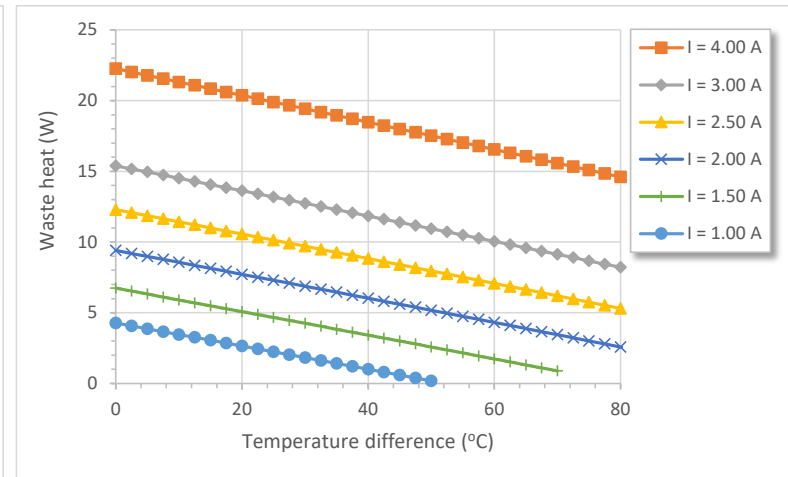
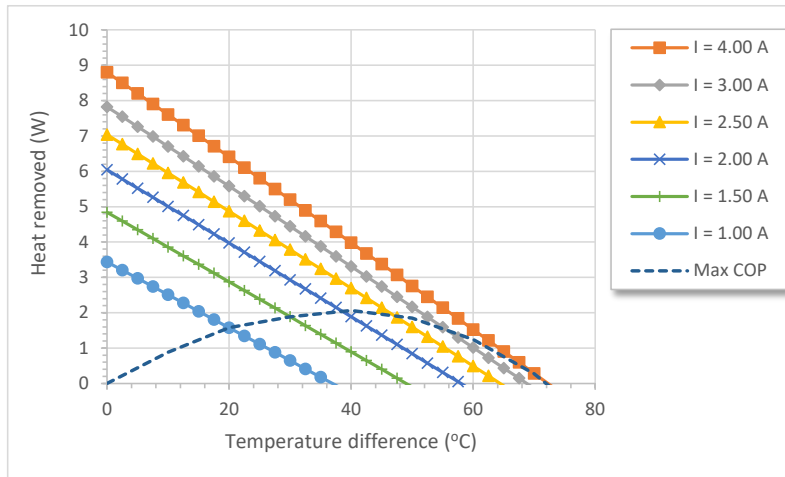

*Note - Waste heat = Heat out of hot side



ET-03I-10-13-S-HI

Peltier Cooler Module

Data sheet - At hot side temperature 50°C

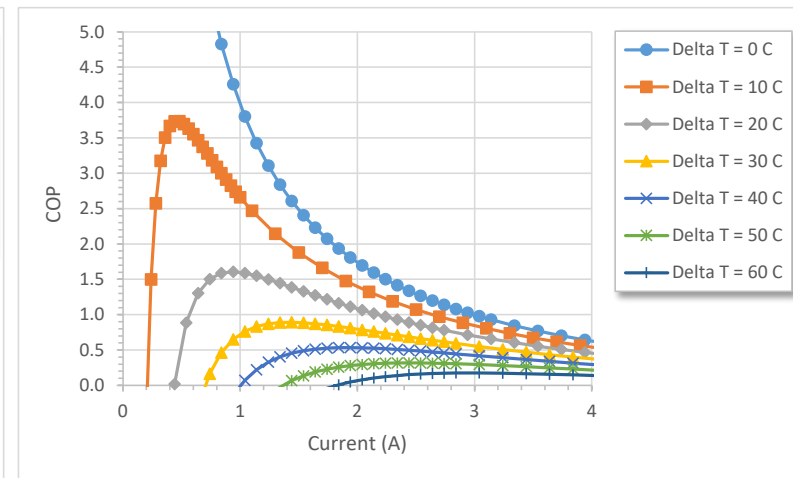
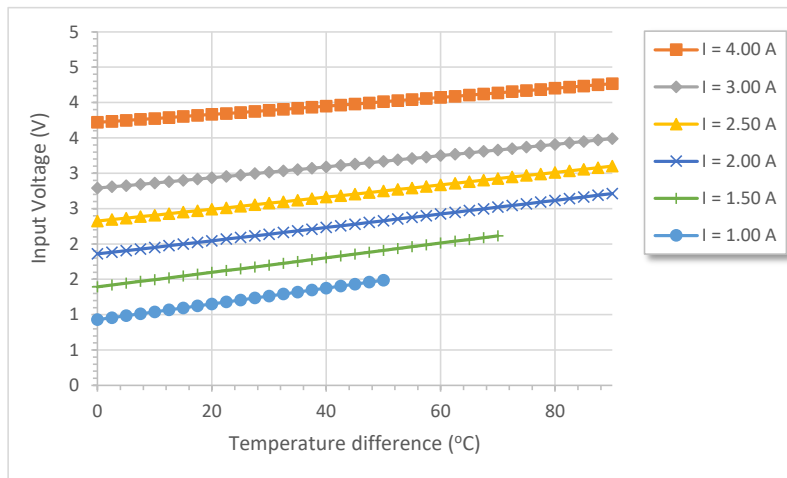
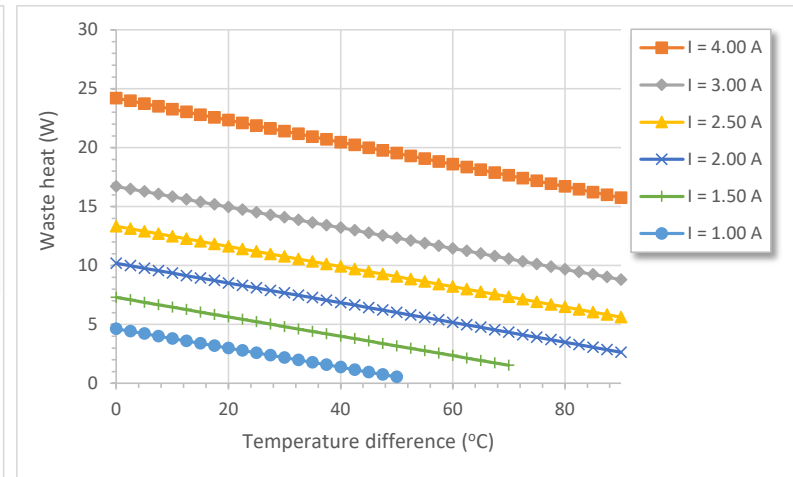
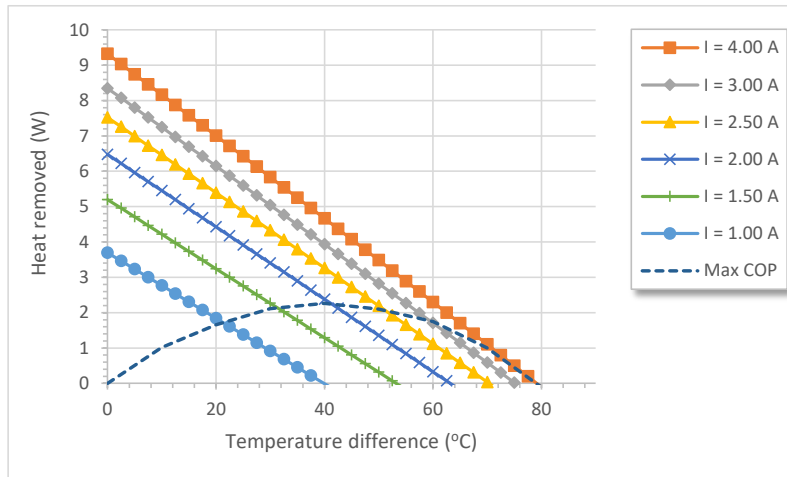

*Note - Waste heat = Heat out of hot side



ET-03I-10-13-S-HI

Peltier Cooler Module

Data sheet - At hot side temperature 75°C

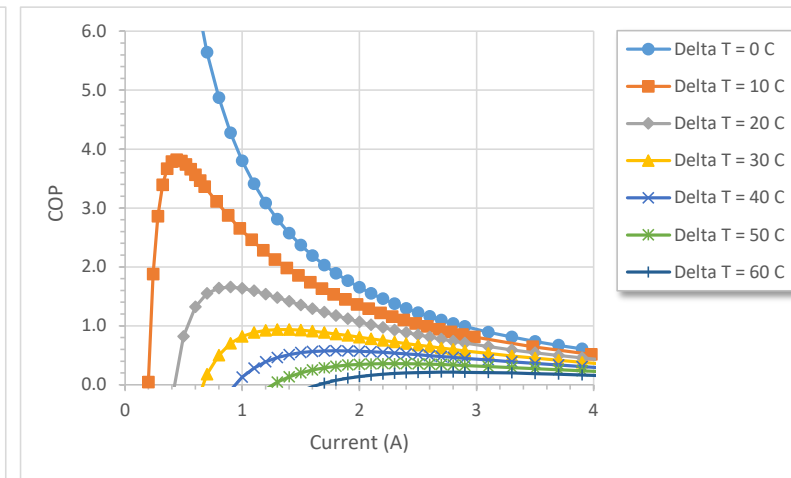
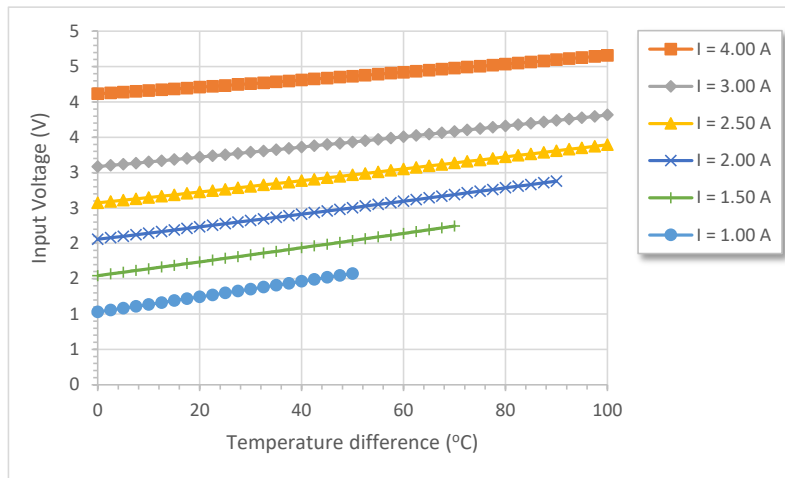
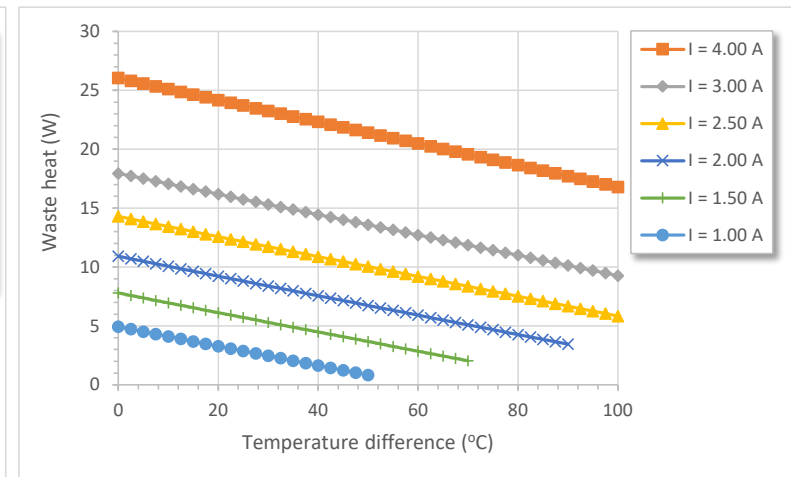
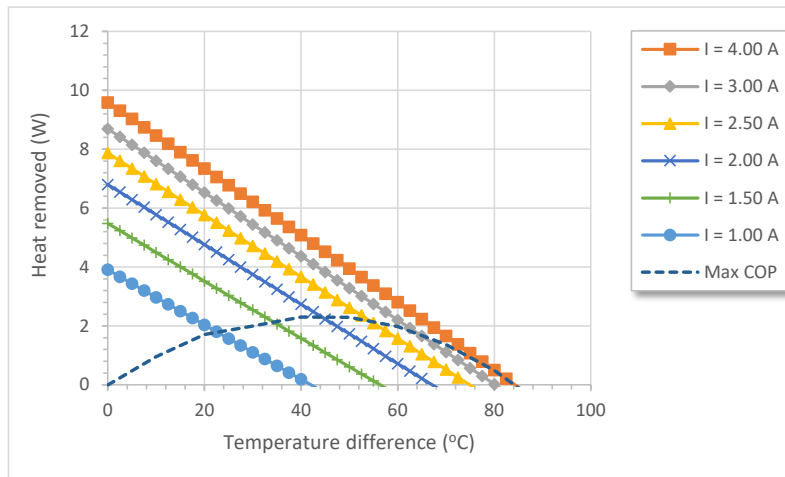

*Note - Waste heat = Heat out of hot side

