

ET-032-14-15-RH

Peltier Cooler Module

Data sheet

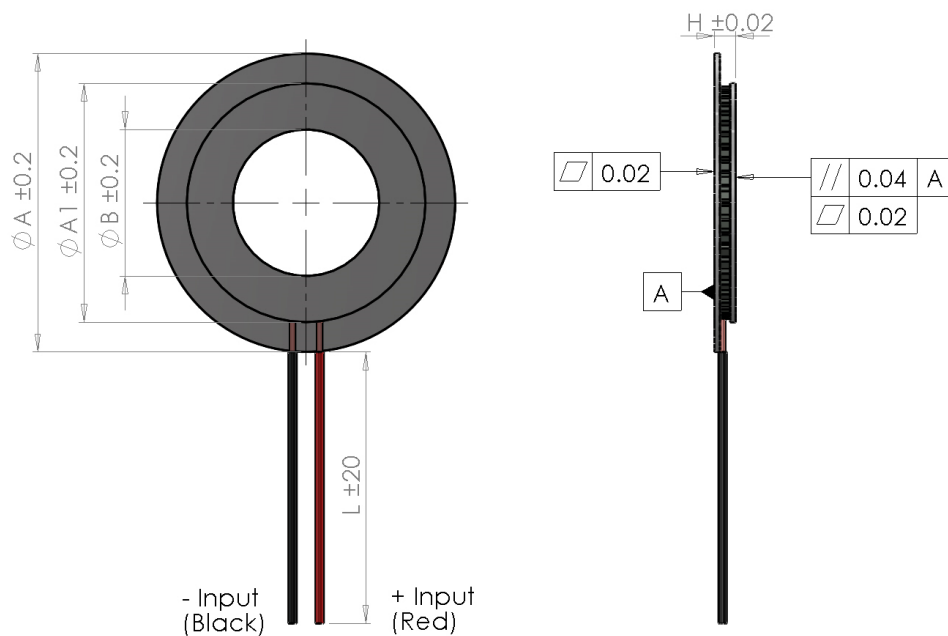

I_{max}	[A]	6
V_{max}	[Vdc]	4.0
$P_c \text{ max}$	[W]	15
ΔT_{max}	[°C]	74
A	[mm]	55
A1	[mm]	44
B	[mm]	27
H	[mm]	3.9
L	[mm]	200
Wire	AWG	n/a

- (At hot side temperature $T_h = 25^\circ\text{C} / 298\text{K}$, under dry N_2)
- $P_c \text{ max}$ = Cooling power at $\Delta T = 0$ and $I = I_{max}$
- ΔT_{max} = Temperature difference at $I = I_{max}$ and $P_c = 0$
- Max hot side temperature $T_h = 90^\circ\text{C}$ for best long term performance
- Max mounting pressure: 1.5MPa
- Wires: UL-style 1569, 105°C (Unstripped)



ET-032-I4-I5-RH

Peltier Cooler Module

Data sheet - At hot side temperature 25°C

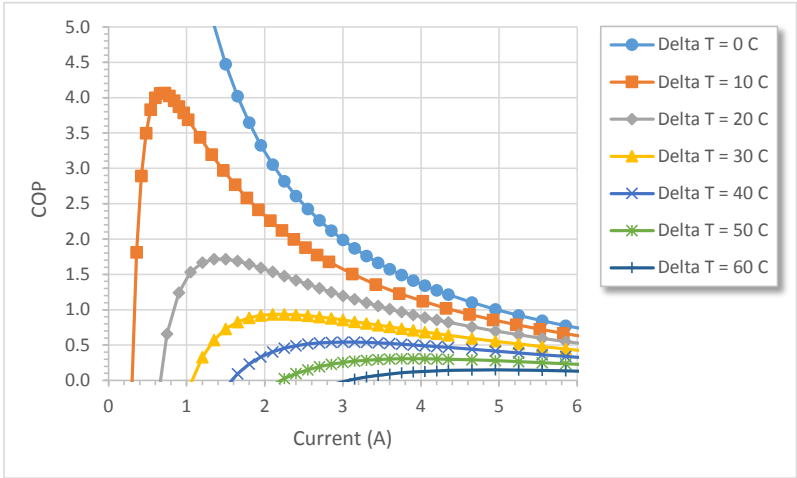
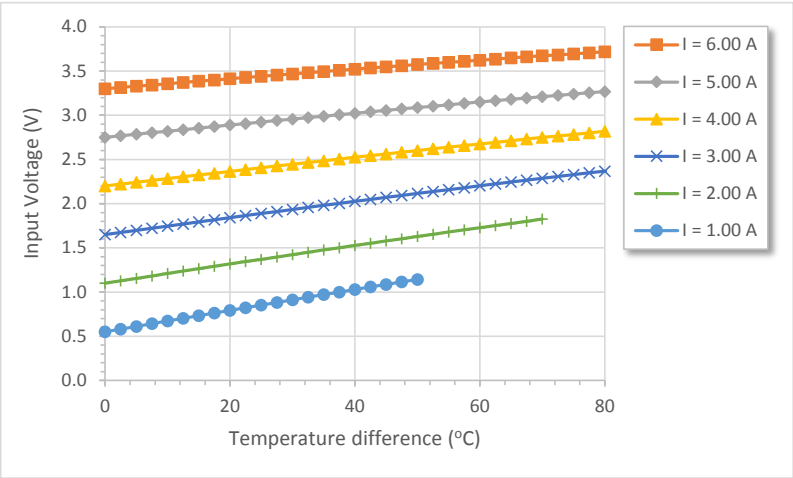
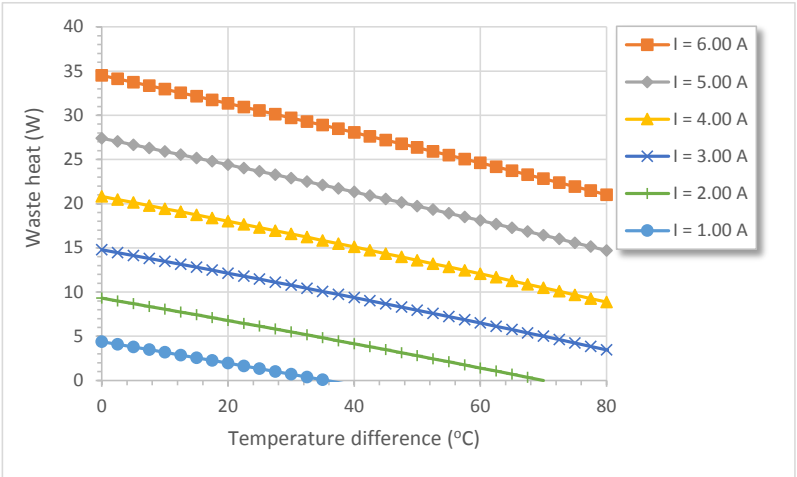
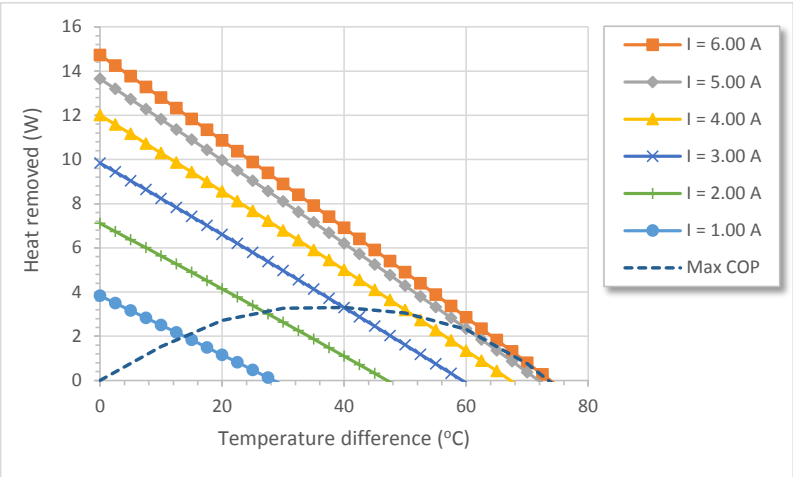

*Note - Waste heat = Heat out of hot side



ET-032-I4-I5-RH

Peltier Cooler Module

Data sheet - At hot side temperature 50°C

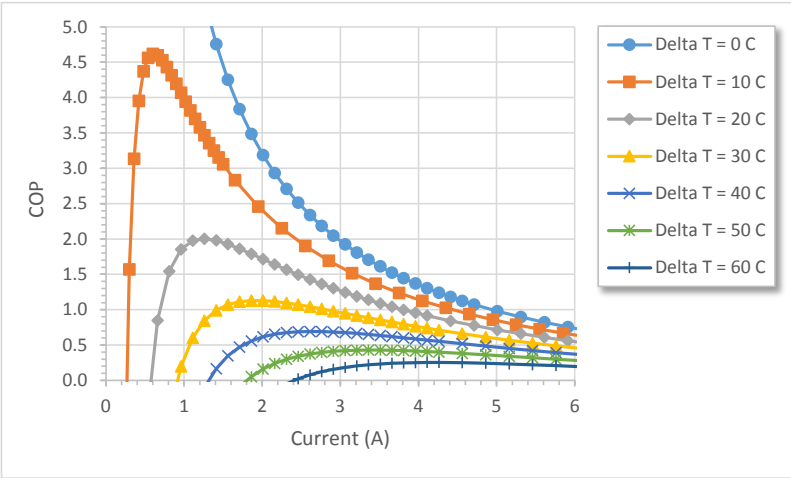
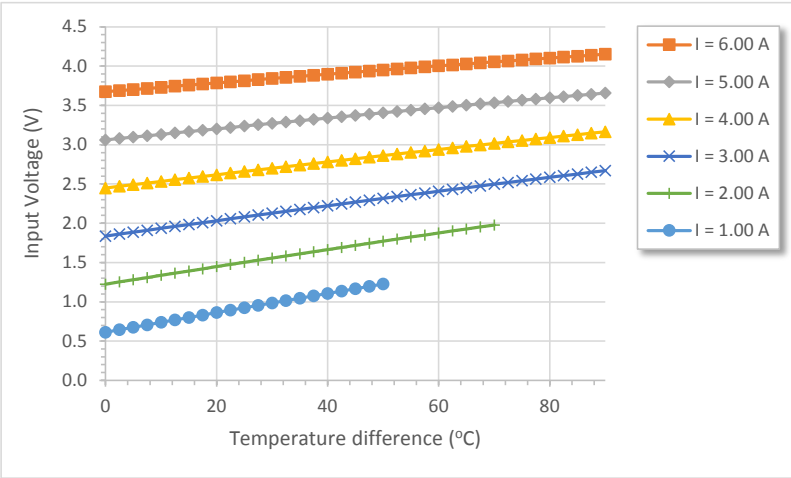
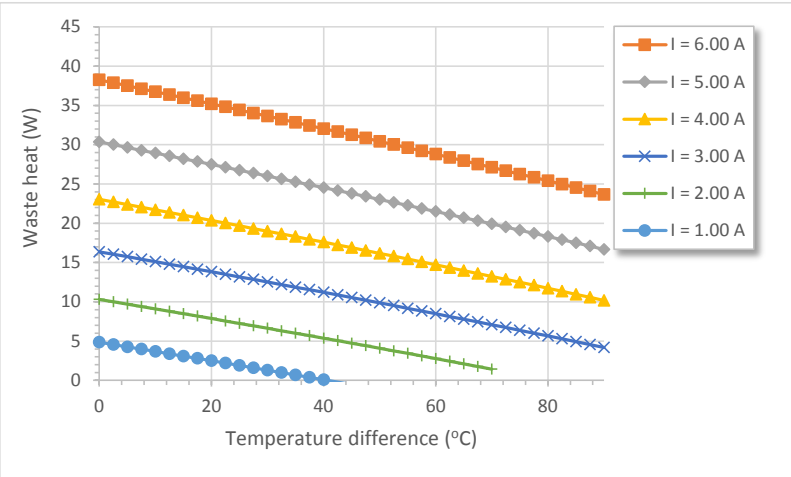
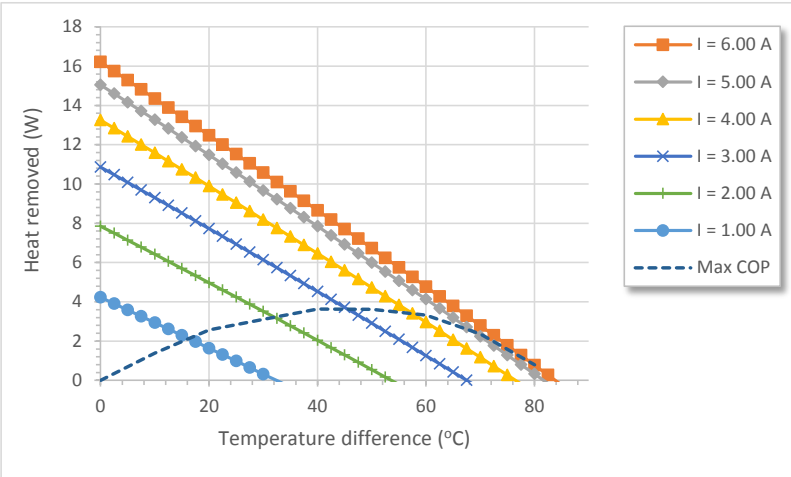

*Note - Waste heat = Heat out of hot side



ET-032-I4-I5-RH

Peltier Cooler Module

Data sheet - At hot side temperature 75°C

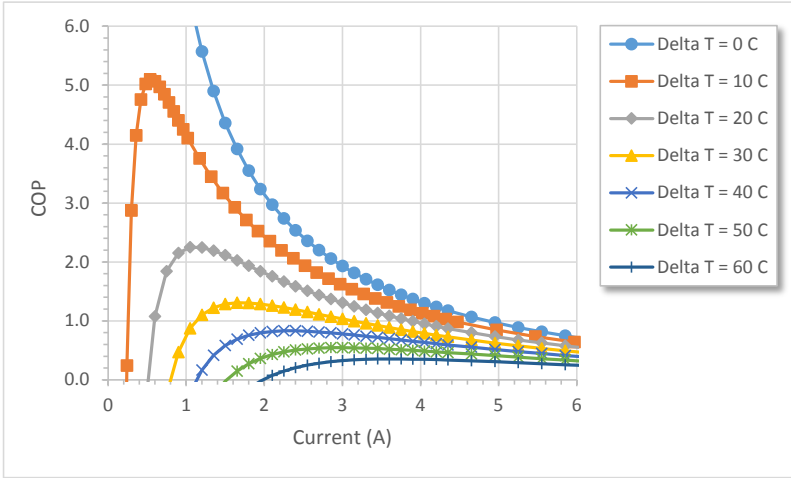
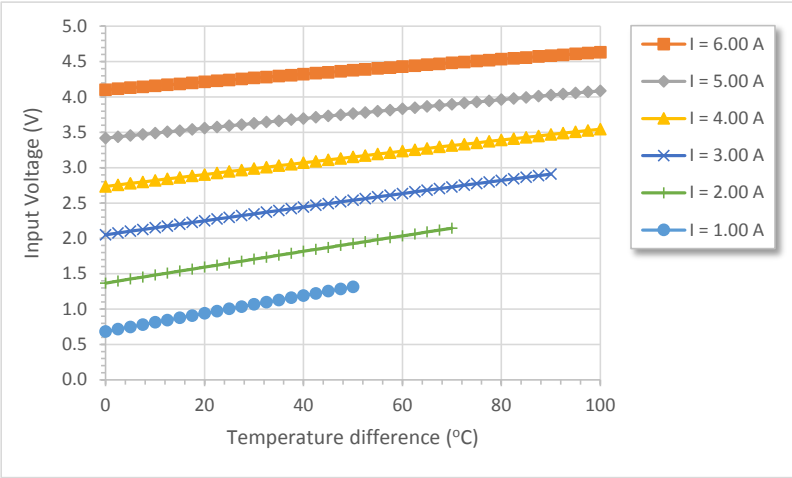
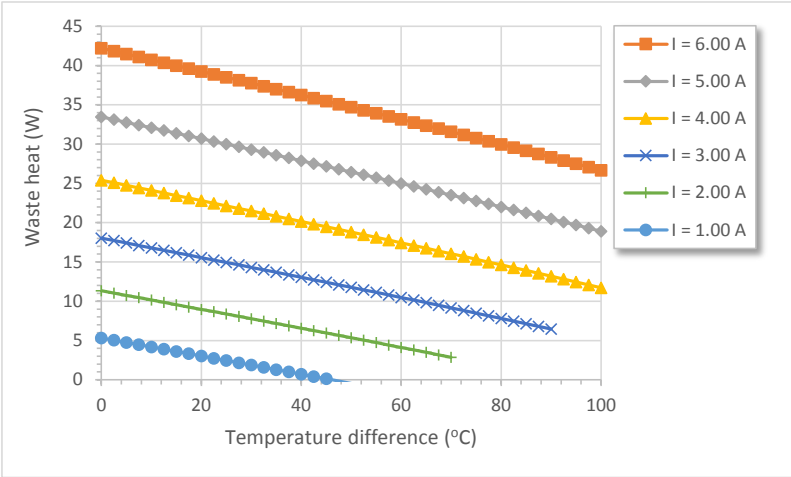
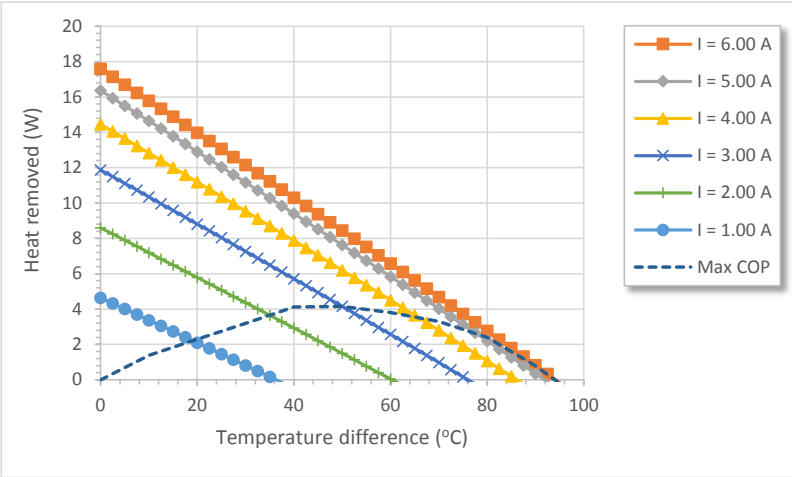

*Note - Waste heat = Heat out of hot side

